



This Online Learning Seminar is available through a professional courtesy provided by:

3M Industrial Adhesives and Tapes Division
Fire Protection Products
3M Center, Building 225-3S-06
St. Paul, MN 55144-1000
Phone: 1-800-328-1687
Email: firetech1@mmm.com
Web: www.3m.com/firestop

START



©2014 3M. The material contained in this course was researched, assembled, and produced by 3M and remains its property. "LEED" and related logo is a trademark owned by the U.S. Green Building Council and is used by permission. The LEED® Rating System was authored by and is the property of the USGBC. Any portion of the Rating System appearing in this course is by permission of the USGBC. Questions or concerns about the content of this course should be directed to the program instructor. This multimedia product is the copyright of AEC Daily.



Through Penetration Firestopping

Presented by: 3M Industrial Adhesives and Tapes Division
Fire Protection Products
3M Center, Building 225-3S-06
St. Paul, MN 55144-1000

Description: Provides an overview of the performance and attributes of firestopping technologies, materials, and products that are used to firestop through penetrations in commercial applications. Industry fire testing standards and third-party listings are also discussed.

To ensure the accuracy of this program material, this course is valid only when listed on AEC Daily's Online Learning Center. Please [click here](#) to verify the status of this course. If the course is not displayed on the above page, it is no longer offered.



The American Institute of Architects · Course No. AEC747 · This program qualifies for 1.0 LU/HSW Hour.

AEC Daily Corporation is a Registered Provider with The American Institute of Architects Continuing Education Systems (AIA/CES). Credit(s) earned on completion of this program will be reported to AIA/CES for AIA members. Certificates of Completion for both AIA members and non-AIA members are available upon request. This program is registered with AIA/CES for continuing professional education. As such, it does not include content that may be deemed or construed to be an approval or endorsement by the AIA of any material of construction or any method or manner of handling, using, distributing, or dealing in any material or product. Questions related to specific materials, methods, and services will be addressed at the conclusion of this presentation.

This course is approved by other organizations. Please [click here](#) for details.

AEC Daily Corporation has met the standards and requirements of the Registered Continuing Education Program. Credit earned on completion of this program will be reported to RCEP at RCEP.net. A certificate of completion will be issued to each participant. As such, it does not include content that may be deemed or construed to be an approval or endorsement by the RCEP.



REGISTERED CONTINUING EDUCATION PROGRAM

Purpose and Learning Objectives

Purpose: Provides an overview of the performance and attributes of firestopping technologies, materials, and products that are used to firestop through penetrations in commercial applications. Industry fire testing standards and third-party listings are also discussed.

Learning Objectives: At the end of this program, participants will be able to:

- recognize different construction types, penetrating items, and the need for through penetration firestopping to help prevent the spread of fire, smoke, and toxic gases
- apply Underwriters Laboratories (UL) system nomenclature to identify through penetration firestop systems
- discuss relevant industry standards and determine the testing requirements for a range of through penetrations
- discuss the attributes of firestop materials and assemblies and their role in saving lives and property, and identify system solutions for through penetration applications, and
- compare today's firestop products and technologies that are incorporated in through penetration commercial applications.

How to Use This Online Learning Course

- To **view** this course, use the **arrows** at the bottom of each slide or the up and down arrow keys on your keyboard.
- To **print or exit** the course at any time, press the **ESC** key on your keyboard. This will minimize the full-screen presentation and display the menu bar.
- Within this course is an  **exam password** that you will be required to enter in order to proceed with the online examination. Please be sure to remember or write down this exam password so that you have it available for the test.
- To receive a **certificate** indicating course completion, refer to the instructions at the end of the course.
- For **additional information** and post-seminar assistance, click on any of the logos and icons within a page or any of the links at the top of each page.

Table of Contents

Overview of Through Penetrations	7
Firestop Materials & System Selection	23
Membrane Penetrations	40
Third-Party Listings	45
Firestop Products & Applications	55
Course Summary	75

Click on title to view



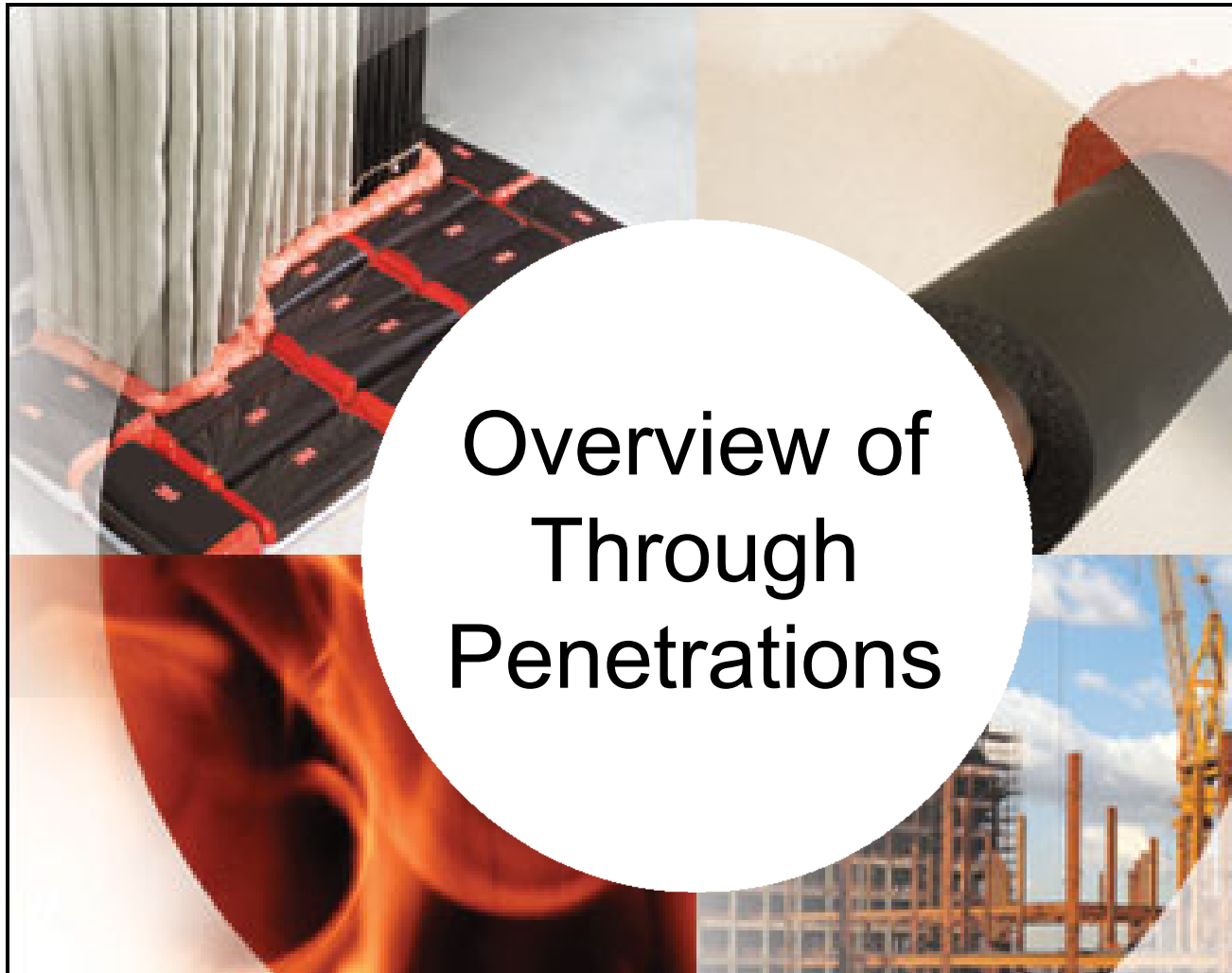

Overview of Through Penetrations

Fire Protection

Every year, building fires kill or injure thousands of people, damage vital equipment, and destroy billions of dollars in property.

What can our industry do to help limit the destructive power of fires in commercial construction?

The traditional approach to fire protection emphasizes active systems and provides tools to limit the damage a fire can do. This includes fire sprinklers, suppression systems, and fire extinguishers, and while these systems are important, they represent only one approach to increasing fire safety.



Fire Protection: Compartmentation

In today's construction, the emphasis is on both containing a fire and limiting fire damage by installing both active systems and passive systems.

Compartmentation is a fire safety method used worldwide where fire-rated construction is used to separate a building into compartments in order to slow the spread of a fire and smoke through a structure, from room to room and floor to floor, thereby helping to protect occupants and sensitive property.

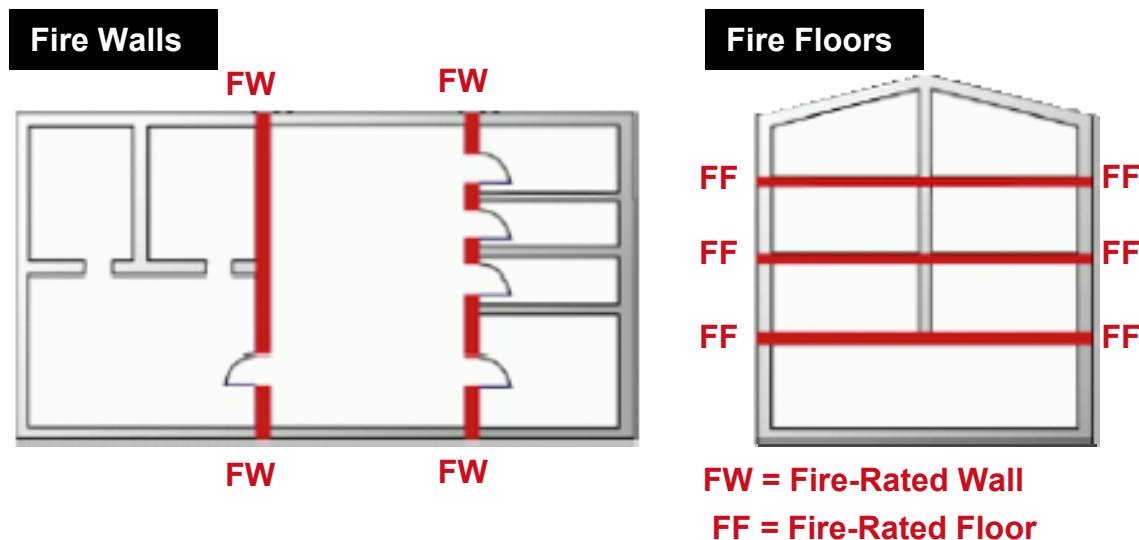

Fire Protection: Containment

Passive firestop systems are designed in accordance with current life safety building regulations to help prevent the spread of fire, smoke, and toxic gas through openings in fire-rated construction created by penetrations (e.g., pipes, cables, ducts, etc.) and gaps (i.e., construction joints) between walls or floors/ceilings in fire-rated construction.

Containment or the firestopping of openings in fire-rated construction re-establishes the integrity and fire rating of a wall, floor, or assembly, and aids in the protection of escape routes.



How a Through Penetration Firestop Works

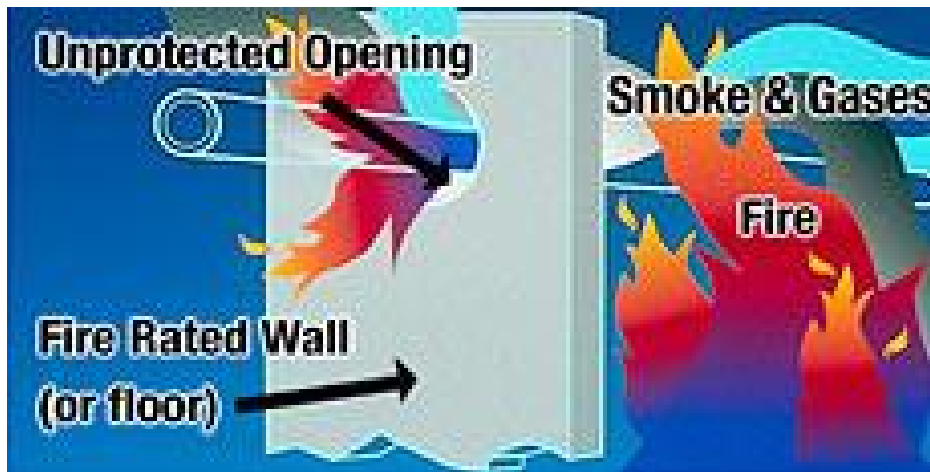

Unprotected Opening

Since fire travels via the path of least resistance, any unprotected opening or gap in a floor or wall can provide a conduit for fire to jump from one room or floor to the next.

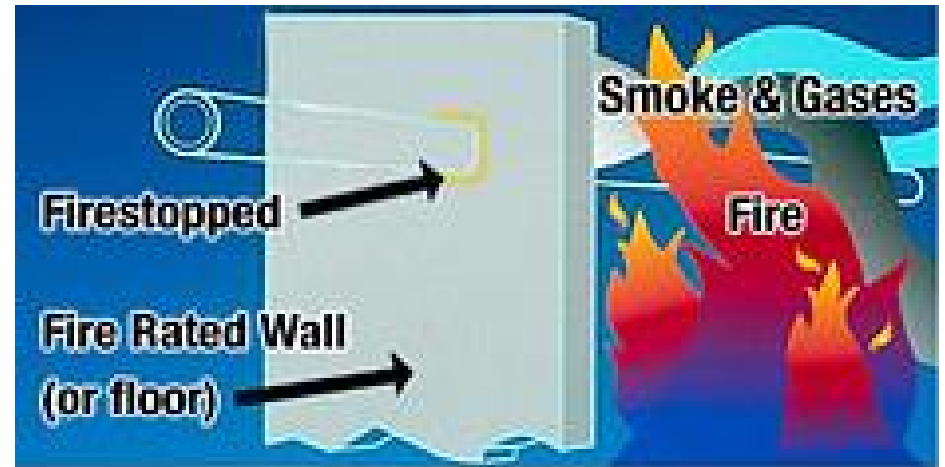

Firestopped Opening

Proper installation of a firestop restricts the movement of a fire into adjacent areas of a building by restoring the integrity of a fire-rated assembly.

What Does an Effective Through Penetration Firestop System Provide?

An effective through penetration firestop system:

- prevents the passage of fire and flames through the penetration for a specified length of time (**F-rating** (required))
- retards the transmission of heat (**T-rating** (required))
- provides an effective smoke and toxic gas barrier (**L-rating** (optional)), and
- provides a water-resistant and/or water-tight seal (**W-rating** (optional)).

Building Codes for Firestopping

Building codes are written for all aspects of construction, including firestopping. Code bodies place an emphasis on approved methods, defined as a material, device, or system tested in accordance with a nationally recognized test standard at a recognized testing facility.

Examples of codes include the following:

- International Code Council (ICC)
- International Building Codes (IBC)
- National Fire Protection Agency (NFPA)
- International Mechanical Code (IMC)
- Uniform Plumbing Code (UPC)
- Uniform Mechanical Code (UMC)

The relevant subsections of the International Building Code are “Through Penetrations,” “Membrane Penetrations,” “Joints,” “Perimeter Joints,” “Fire Barriers,” and “Smoke Barriers.”

Fire Test Standards for Through Penetrations

The two commonly cited fire protection standards for through penetrations are:

- ASTM E814 Standard Test Method for Fire Tests of Penetration Firestop Systems, and
- UL 1479 Fire Tests of Through-Penetration Firestops.

To meet these standards, all parts of the firestop system assembly, including through penetration firestopping products, must meet the established standards for containing a fire within the established test duration.

By testing to the ASTM E814 standard, through penetration firestop systems are checked for exposure to heat and water, as well as impact, corrosion, and cooling.

Fire Test Standards for Through Penetrations

According to the IBC, through penetrations must be protected by an approved penetration firestop system installed as tested in accordance with ASTM E814, with a minimum positive pressure differential of 0.01 inch (0.254 mm).

These systems must have:

- an F-rating of not less than the required fire resistance rating of the wall penetrated, and
- an F-rating equal to the T-rating if the through penetration is located outside a wall assembly.

The exception to this is:

- a T-rating is not required for floor penetrations that are contained and located within a wall cavity.

The T-rating which is required is typically expressed in hours and indicates the length of time that the unexposed surface of a firestop assembly will not exceed 325°F (162.8°C) above its initial temperature during the ASTM E814 fire test.

To receive either of the above ratings, the firestop must pass the hose stream test.

How Is the F-Rating Determined?

The top photo shows an example of a fire test assembly with ten systems installed per UL system instructions. Note, each system is evaluated separately.

Once the frame of the assembly is mounted to the furnace, the furnace is started and programmed to follow the ASTM E119, ASTM E1529, or UL 1709 time temperature curves.

For the duration of the test, no flame can penetrate the non-fire side of the assembly being tested at the location of the through penetration. However, flames can extend beyond the penetrants (e.g., metal pipes). Smoke passage is not a criteria for this portion of the fire test.



How Is the T-Rating Determined?

The mandatory T-rating is a measure of a firestop system's thermal conductivity and the time that an assembly maintains the temperature of the thermocouples (TCs) on the non-fire side of the assembly below the required temperatures (325°F plus (+) ambient temperature for any single TC).

As shown in this photo, during the fire test, TCs are placed in four locations:

- 4" or 12" from the opening (depending on the side of the assembly) (TC1)
- 1" above the opening on the penetrating item (TC2)
- on the opening (on the firestop) (TC3)
- 1" from the opening (TC4)

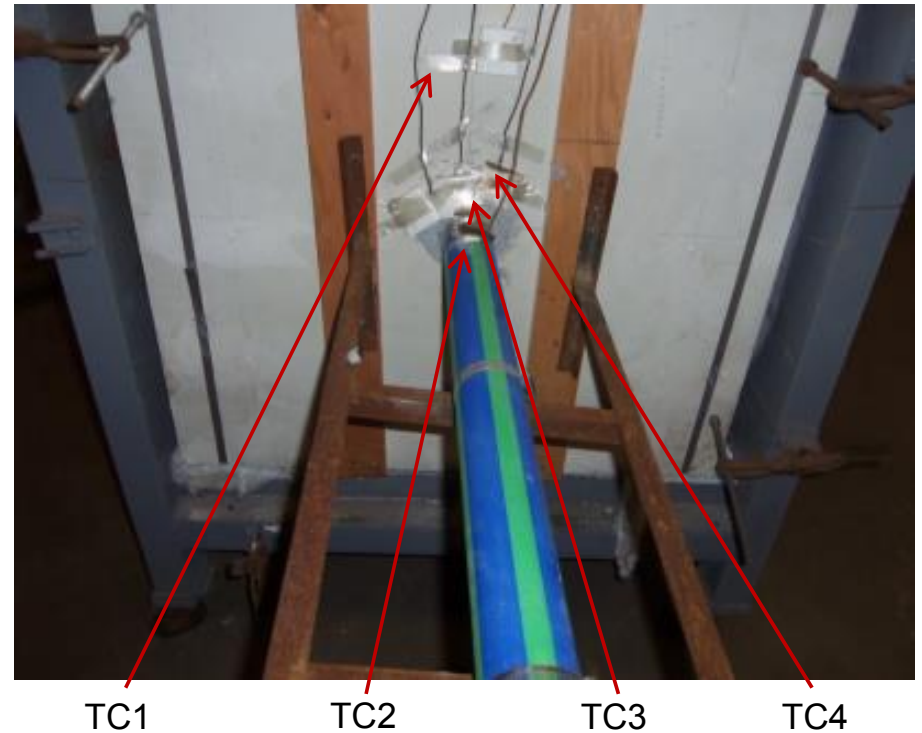

ASTM E814/UL 1479

This test method requires a severe fire exposure with temperatures reaching as high as 2000°F (1093.2°C) in a four-hour period.

The firestop system must prevent the passage of fire and heat through the test assembly.

During testing, the following required temperatures must be met for different rated systems:

- room temperature to 1000°F in 5 minutes
- 1700°F (926.6°C) for 1 hour
- 1850°F (1009.9°C) for 2 hours
- 1925°F (1051.6°C) for 3 hours, or
- 2000°F (1093.2°C) for 4 hours.

Exposure time is determined by the desired rating (1, 2, 3 or 4 hours). As soon as the frame is removed from the furnace it is rolled to the hose stream station.



Frame is removed from the furnace.



Exposed side of assembly frame. Note the cracks in the gypsum and the plastic that has melted away.

ASTM E814/UL 1479: Hose Stream Test

After exposing the test assembly to severe fire exposure, it is immediately subjected to a powerful water hose stream. The surface of the assembly is bombarded, including the firestop penetration, with water as cold as 50°F (9.9°C) at a pressure of up to 45 PSI for as long as three seconds per square foot of test surface. The objective of this test is to see if the firestop system can withstand the impact, erosion, and cooling effects of the hose stream.



ASTM E814/UL 1479: Hose Stream Test

These photos show tested assemblies after the hose stream test. Note, the furnace facing gypsum has been removed by the hose stream's erosive forces. It is only because both sides of the wall are firestopped that these assemblies were able to pass this portion of the test.

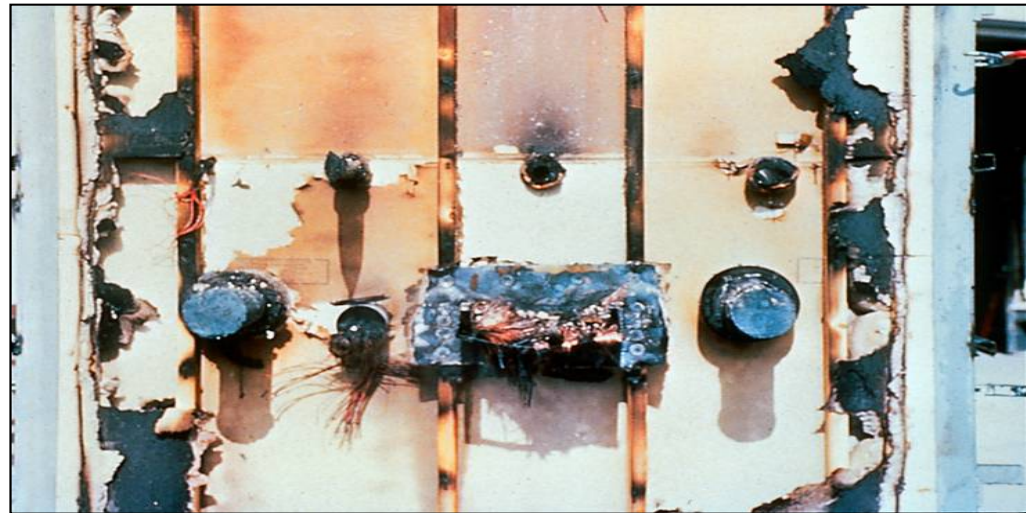
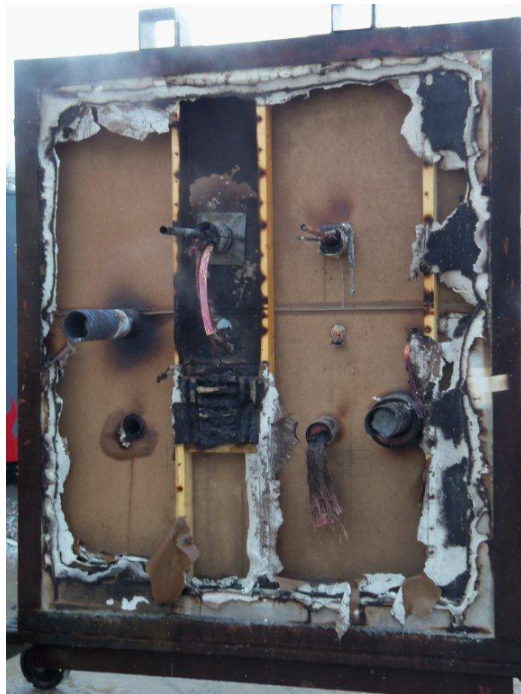

How Is the L-Rating Determined?

The optional L-rating is a measure of air flow or leakage through a firestop system.

To determine an L-rating of a firestop system, a test chamber is constructed to represent the through penetration system to be tested, and the temperature of the chamber is set to 75°F. A pressure of 0.30 ± 0.01 " of water (75 ± 2 Pa) is applied to the chamber, and the air flow rate out the through penetration is measured and reported. Next, the chamber temperature is increased to 400°F, and the test is repeated.

L-ratings are measured in cubic feet per minute per square foot of opening (CFM/ft²), or CMM/m² (metrics). L-ratings help in determining the suitability of firestop systems for the protection of penetrations and miscellaneous openings in floors and smoke barriers for the purpose of restricting the movement of smoke, in accordance with the National Fire Protection Association Life Safety Code, NFPA 101.

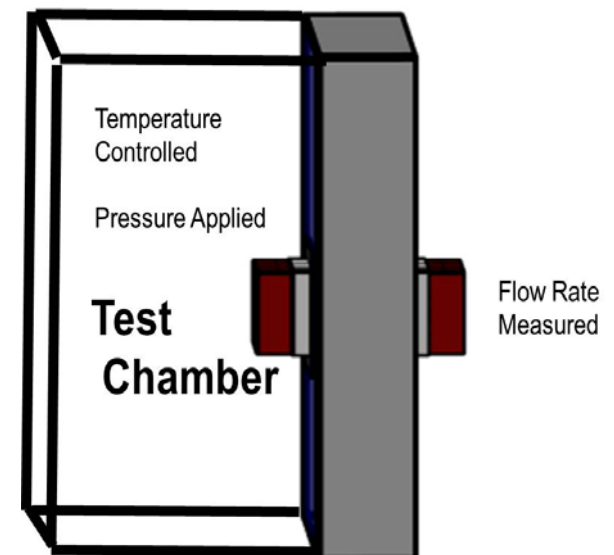

How Is the W-Rating Determined?

The optional W-rating indicates the effectiveness of a firestop material in restricting the flow of water through penetrations in ceilings, floors, and walls occurring from exposure to the elements during construction and/or from other sources after occupancy.

To determine a W-rating, a through penetration system is constructed per the desired listing and a reservoir is installed around the assembly or firestop system. 36" of water and 36" of water column are placed inside the reservoir and the reservoir is pressured for 72 hours.

To receive a UL W-rating Class 1, a firestop system must restrict the flow of water for the full 72 hours. No leakage is allowed.

Immediately after the water is removed, the firestop system must pass the ASTM E814 fire and hose stream tests.

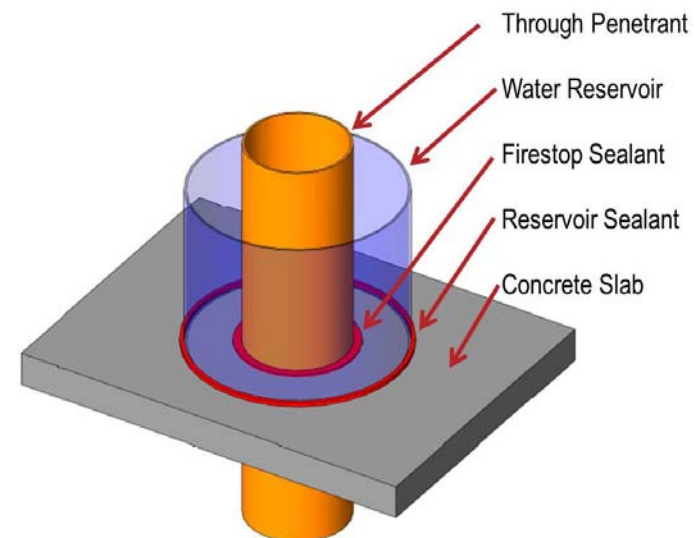



Firestop Materials & System Selection

Firestop Technologies

The four main through penetration firestop technologies are: intumescent, endothermic, ablative, and insulative.

Intumescent firestops are designed to expand when exposed to heat (as much as 25 times in volume) and form a high-strength, insulating, fire-resistive char. This high-strength char is as important as the swelling action in that it allows the seal to resist the thermal and dynamic shocks of the actions that occur within a fire, including the fire suppression activities.

Intumescent Technology



Firestop Technologies

Endothermic firestops are designed to release chemically bound molecules of water when exposed to heat. As the temperature of a fire increases, it drives water out of the material in the form of steam that in turn provides a cooling effect.

Endothermic Technology

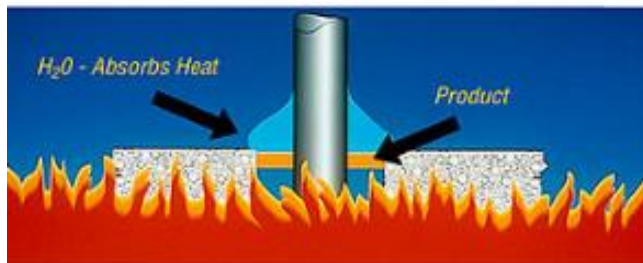

As fire intensifies, chemically bound water molecules are released



Electrical Panel

Firestop Technologies

Ablative firestop materials absorb heat and form a hard char with thermal insulation characteristics to help seal voids when exposed to heat. The charring acts as an insulative layer between the fire and the remainder of the firestopping product. Ablative firestopping materials often contain silicone.

Ablative Technology

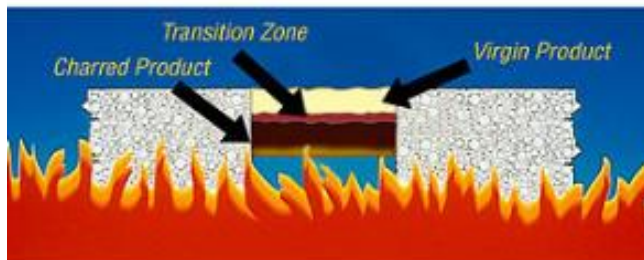

As fire intensifies, a hard char with thermal insulation is formed

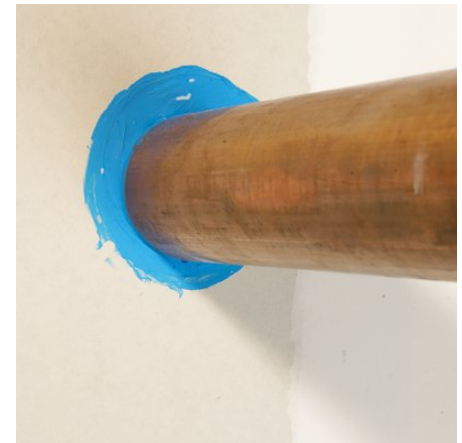

Firestop Technologies

Insulative firestop technologies provide a barrier against heat and fire, thus helping to maintain and protect the assembly.

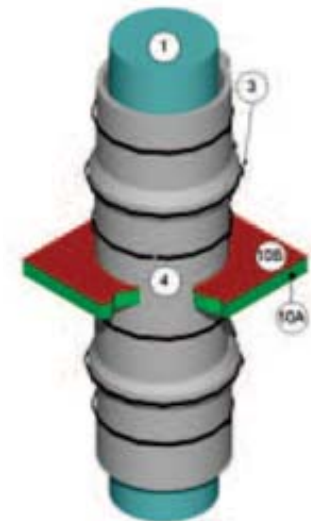

UL System Selection: Factors to Consider

The remainder of this section discusses critical factors which should be considered before a UL firestop system for a specific application is selected, including:

- What is the floor or wall construction type and thickness?
- What is the hourly rating of the assembly?
- What is/are the penetrating item(s)?
- What is the size of the penetrating item(s)?
- What is the annular space?
- Is a sleeve optional or required?
- What is the percent cable fill?
- What packing materials are required?
- What is the insulation type and thickness?
- Are there any special conditions or considerations?

Other factors to consider include:

- Fire severity
- Installation quality (ease of installation)
- Additional requirements (e.g., STC rating, W-rating, L-rating)

Substrate Type & Thickness

The characteristics and thickness of the construction material or substrate being used will affect the type of firestop product(s) and system(s) needed to firestop your application. Generally, with all things being equal, thicker substrates absorb more heat (and are easier to firestop).

Possible substrates include:

- gypsum wall board assemblies
- poured-in-place concrete
- pre-cast concrete
- hollow-core concrete
- post-tension concrete
- CMU, concrete block wall
- fluted metal deck, and
- wood frame assemblies.



Concrete

Wood Frame

Gypsum

Type of Substrate & Thickness

It is important to understand the critical dimension for firestopping of fluted metal decks and hollow core concrete.

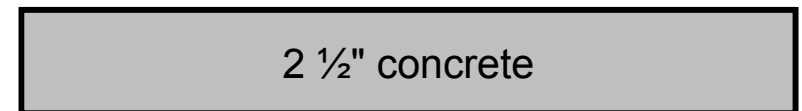

Less heat absorption

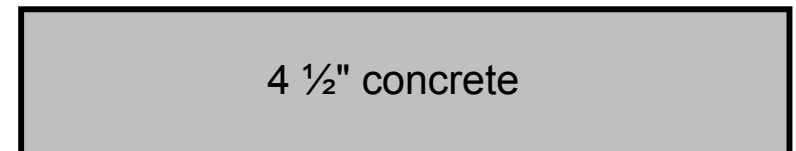

Greater heat absorption

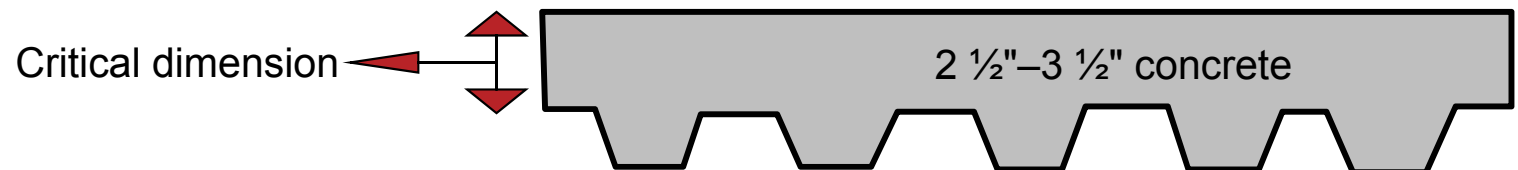

Hourly Rating

Each construction type is designed for a specific hourly rating (F-rating). In general, when choosing a firestop system, its hourly rating must be equal to the hourly rating of the construction type.

Remember, firestop products are part of a firestop system. It is the complete system that receives an hourly rating, not the products themselves.

System No. C-AJ-1000

March 15, 2007

F Ratings – 2, 3, and 4 Hr (See Items 2A and 4)

T Rating – 0 Hr

L Rating At Ambient – 2 CFM/sq ft

L Rating At 400 F – less than 1 CFM/sq ft

W Rating – Class 1 (See Item 4)

Types of Penetrating Items

There are many different types of penetrating items which need firestopping. Each item may react differently during a fire—some are combustible, some are not. Knowing the type of penetrant to be firestopped will help you select the correct firestop product(s) and system detail. Possible penetrants which may require firestopping include:

- metallic pipe (copper, cast iron, EMT, conduit, metal clad, steel, aluminum)
- plastic pipe (ccPVC, PVC, CPVC, FRPP, PVDF, ENT, ccABS, ABS)
- glass pipe
- fiberglass pipe
- cables (thermostat, communication, power and control, coaxial, romex, fiber optic, metal clad, SER)
- insulated pipe (type of insulation) (fiberglass, foamglass, AB/PVC, mineral wool)
- cable trays (aluminum, steel)
- blank openings
- air, chemical, and grease ducts (aluminum, steel), and
- any combination of these items.

Size of Penetrating Items

Knowing the size of the penetrating item is a significant factor in choosing a firestop system. For instance, firestopping a 2-inch plastic pipe requires different product(s) and system detail when compared to firestopping a 10-inch plastic pipe. The size of a pipe, cable, or even the insulation thickness all can affect how each penetrating item reacts in a fire.

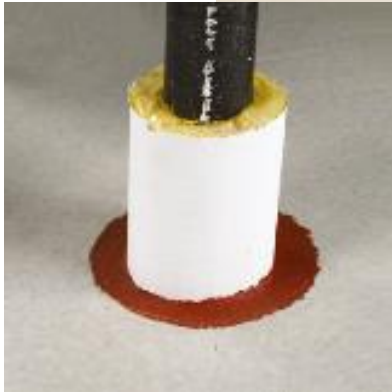
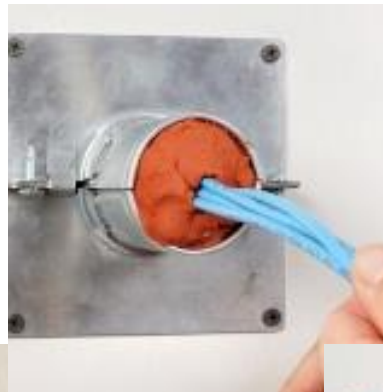

Annular Space

Annular space is the distance between the penetrating item and the periphery of the opening or the distance between multiple penetrations. It's important to note the minimum and maximum measurements and whether the system indicates if a point of contact is allowable.

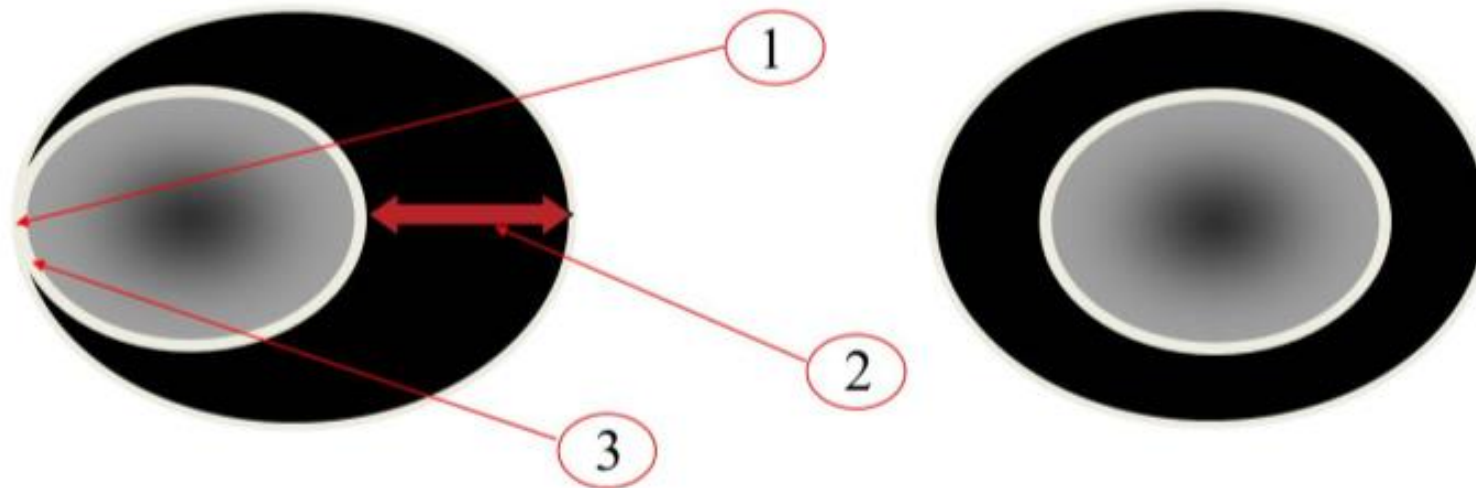

1. Minimum distance between penetrant and side of hole
2. Maximum distance between penetrant and side of hole
3. Make sure the system indicates point of contact is allowable (if applicable)

Annular Space

Firestop materials are installed within the openings and around the penetrants. A firestop system detail will specify the amount of annular space permitted.

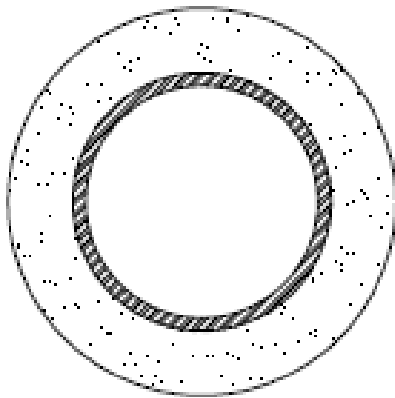

Pipe centered
in opening

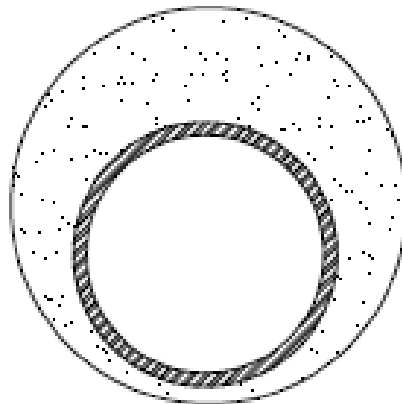

Pipe off-centered
in opening

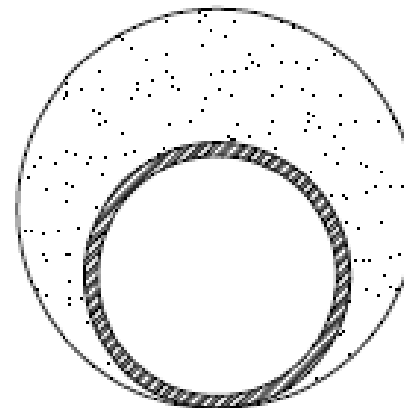

Pipe at point of
contact in opening



Pipe at continuous
point of contact in
opening

Sleeve Effect

In some assemblies, a steel sleeve is required as part of the assembly. A sleeve will protect the penetrant (e.g., cable) and act as a type of guard or strengthening. The firestop system detail tells you whether or not the system has a sleeve option.

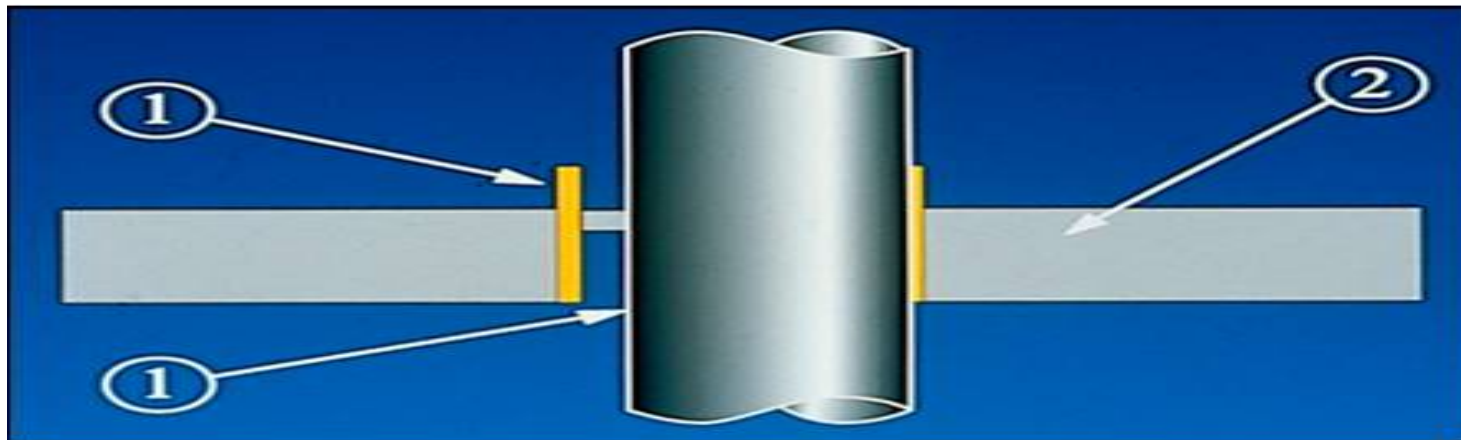

1. Two heat sources working on seal
2. Compounded by thinner concrete

Percent Cable Fill

The firestop system detail also states what calculated percentage cable fill is allowed, and what size and type of cables may be used through the penetration.

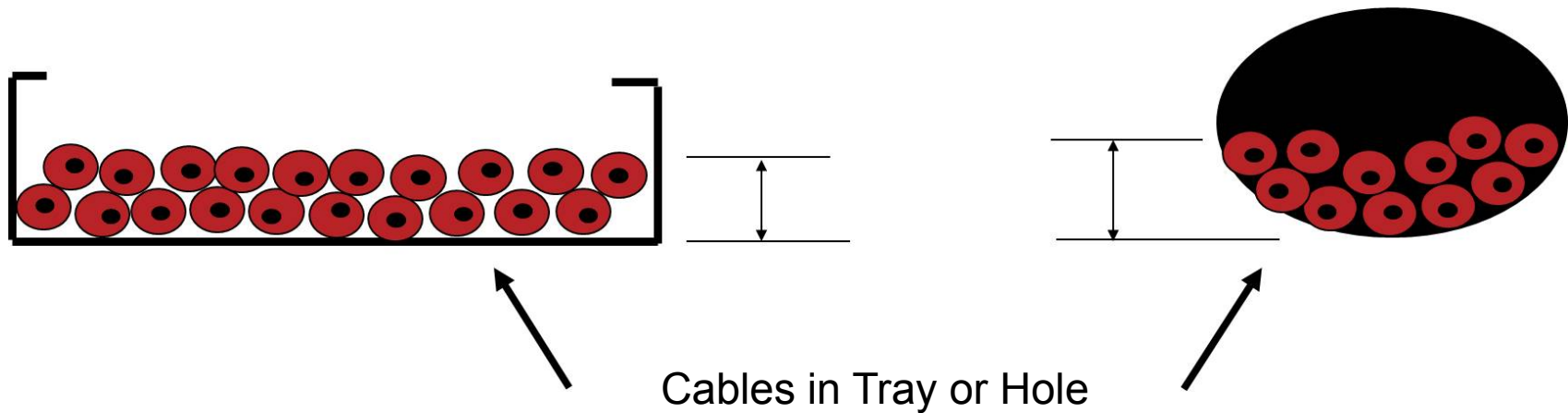

Actual (calculated) % fill equals $\frac{1}{2}$ of visual

Packing Materials

Packing materials are required in many system details. Again, the system detail will tell you what type of packing materials are acceptable in the assembly, and the orientation (e.g., layered) of the packing material. Inappropriate materials (e.g., combustible) that are used in an inappropriate manner (e.g., stuffed into the opening) are a fire hazard.

Types of packing materials include (listed in order of thermal performance):

- ceramic blanket/wool
- mineral wool fire barrier packing material
- Fiberglass
- backer rod (paper, cardboard), and
- nothing.



Types of Insulation

A variety of types of insulation are used in the construction industry today. Each type reacts differently during a fire. It's important to know the burning characteristics and fire resistance properties of commonly used insulations so they can be properly firestopped.

Commonly used insulations include:

- cellular glass insulation
- Fiberglass
- mineral wool
- AB/PVC insulation
- polyethylene
- calcium silicate
- polyisocyanate
- EPDM
- perlite, and
- polystyrene.



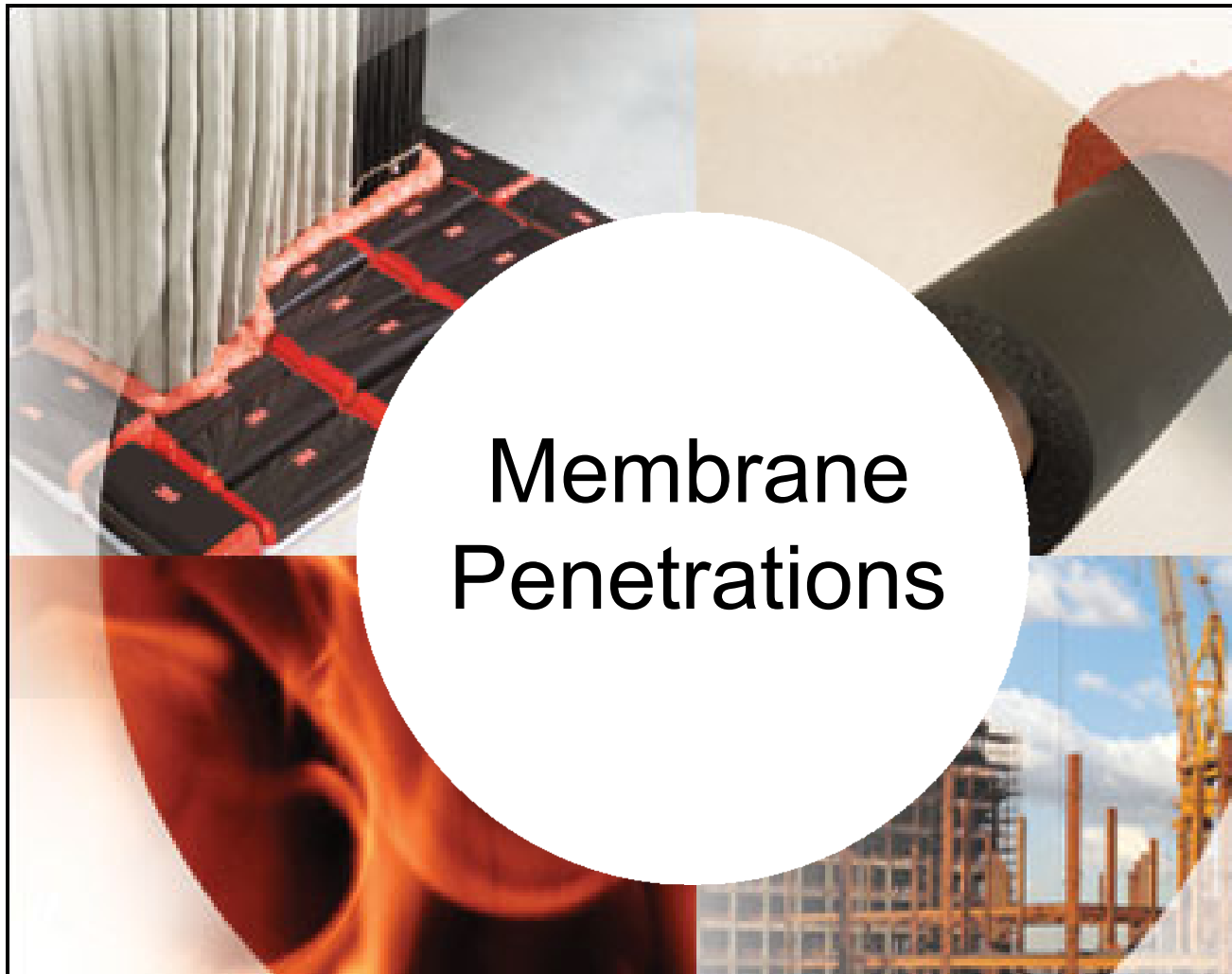

What Is a Membrane Penetration?

When cables, pipes, electrical boxes, tubes, combustion vents, wires, or similar items penetrate only one side of a wall, floor, or floor/ceiling assembly, the condition is known as a membrane penetration. The membrane may be a ceiling tile, a concrete masonry unit (block), concrete wall, or gypsum wallboard.

Membrane penetrations are firestopped in a similar manner as through penetrations, but with a membrane penetration, the firestop is installed on the penetrated side only.

Membrane penetrations in fire-resistance rated assemblies must meet specific installation conditions.



Membrane Penetration Exceptions

Exceptions to the test criteria are permitted for any of the following:

- Ceiling penetrations that are not part of a fire-resistance rated floor/ceiling or roof/ceiling assembly
- In ceilings, where metallic item penetrations where the annular space is protected by an approved material and the total area of penetrations does not exceed 100 in² (645 cm²) in any 100 ft² (9.3 m²)
- In walls or partitions, where steel outlet box is less than 16 in² (103 cm²), provided that the openings do not exceed 100 in² (645 cm²) for any 100 ft² (9.3 m²), and the boxes are adequately spaced apart on opposite sides of the wall (separated by a horizontal distance of more than 24" (60.96 cm))
- Where listed electrical boxes are installed

Electrical Outlet Boxes

Per UL Fire Resistance Directory – Volume 1:

- The surface area of individual metallic outlet or switch boxes shall not exceed 16 in². The aggregate surface area of the boxes shall not exceed 100 in² per 100 ft² of wall surface.
- Boxes located on opposite sides of walls or partitions shall be separated by a minimum horizontal distance of 24". Boxes shall not be installed on opposite sides of wall or partitions of staggered stud construction. The minimum separation distance may be reduced when “Wall Opening Protective Materials” (CLIV) are installed according to the requirements of their Classification.

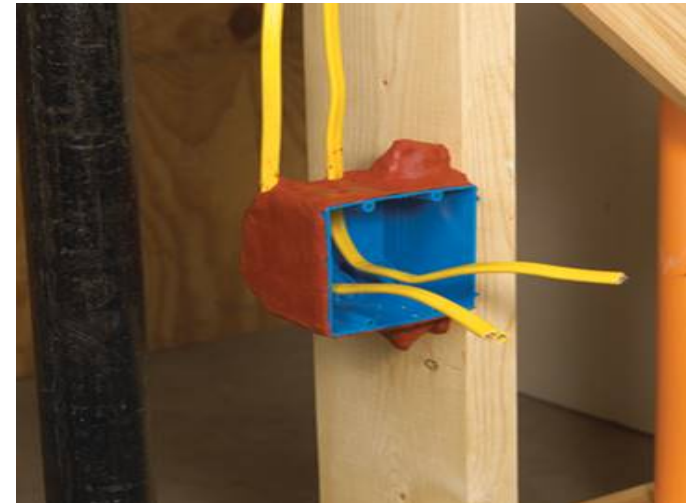

Panel & Box Protection

A steel box must be secured to steel studs with steel screws after the application of the firestop material on the exterior surfaces of the steel box. The bottom and/or top of the steel box may be penetrated by up to 2", maximum 1½" (38 mm), diameter copper, steel, or iron pipes or tubes.

A steel box is defined as: maximum 19" (483 mm) wide by maximum 32" (813 mm) high by maximum 3 ½" (89 mm) deep recessed steel utility box with hinged steel door and mounting flange.



Safety deposit box



Elevator call box



Valve box
(medical gas)



Electrical panel



Identifying a Firestop System

A through penetration firestop system is a specific construction consisting of a wall or floor assembly, a penetrating item passing through an opening in the wall or floor assembly, and the materials designed to prevent the spread of fire through the opening.

Concrete floors and walls

- blanks
- busways
- cable trays
- cables
- combos
- insulated pipes
- metallic pipes
- misc. mechanical
- non-metallic pipes

Floor/ceiling

- cables
- combos
- insulated pipes
- metallic pipes
- misc. mechanical
- non-metallic pipes

Gypsum walls

- blanks
- busways
- cable trays
- cables
- combos
- insulated pipes
- metallic pipes
- misc. mechanical
- non-metallic pipes



UL System Nomenclature

Through penetration firestop systems tested at Underwriters Laboratories (UL) are identified by an alphanumeric identification system.

The first alpha component identifies the type of assembly being penetrated, the second alpha component(s) identify the construction type, and the numeric component identifies the type of penetrating item and system manufacturer.

System No. C-AJ-1000
March 15, 2007
F Ratings – 2, 3, and 4 Hr (See Items 2A and 4)
T Rating – 0 Hr
L Rating At Ambient – 2 CFM/sq ft
L Rating At 400 F – less than 1 CFM/sq ft
W Rating – Class 1 (See Item 4)

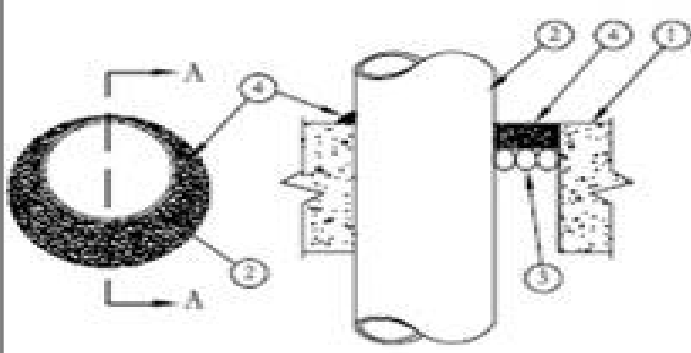

UL System Nomenclature

The first alpha component identifies the type of assembly being penetrated.

- **F**—a floor
- **W**—a wall
- **C**—either a floor or a wall

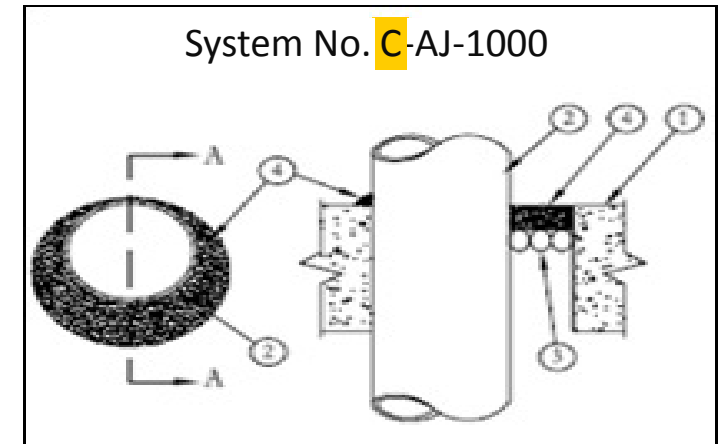

Example:

- A floor or wall is being penetrated

UL System Nomenclature

The second alpha characters signify the construction type.

- **A**—concrete floors with a minimum thickness less than or equal to 5" (12.74 cm)
- **B**—concrete floors with a minimum thickness greater than 5" (12.74 cm)
- **C**—framed floors
- **D**—steel decks in marine vessels
- **E**—floor/ceiling assemblies consisting of concrete with membrane protection
- **F** through **I**—not used at present time
- **J**—concrete or masonry walls with a minimum thickness less than or equal to 8" (20.32 cm)
- **K**—concrete or masonry walls with a minimum thickness greater than 8" (20.32 cm)
- **L**—framed walls
- **M**—bulkheads in marine vessels
- **N**—composite panel walls
- **O** through **Z**—not used at present time

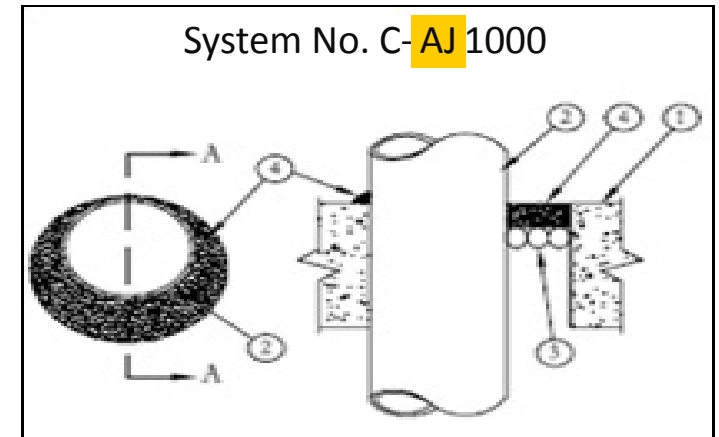

Example:

Construction type is:

- concrete floors with a minimum thickness less than or equal to 5" (12.74 cm), and
- concrete or masonry walls with a minimum thickness less than or equal to 8" (20.32 cm).

UL System Nomenclature

The numeric component uses sequential numbers to identify the penetrating item. In through penetration system nomenclature, the first digit signifies the type of penetrating item. The next three numbers are sequential and are proprietary to a specific manufacturer.

- 0000–0999 - no penetrating items
- 1000–1999 - metallic pipe, conduit, or tubing
- 2000–2999 - non-metallic pipe, conduit, or tubing
- 3000–3999 - electrical cables
- 4000–4999 - cable trays with electrical cables
- 5000–5999 - insulated pipes
- 6000–6999 - miscellaneous electrical penetrants such as buss ducts
- 7000–7999 - miscellaneous mechanical penetrants such as air ducts
- 8000–8999 - groupings of penetrations including any combination of items listed above
- 9000–9999 - not used at present time

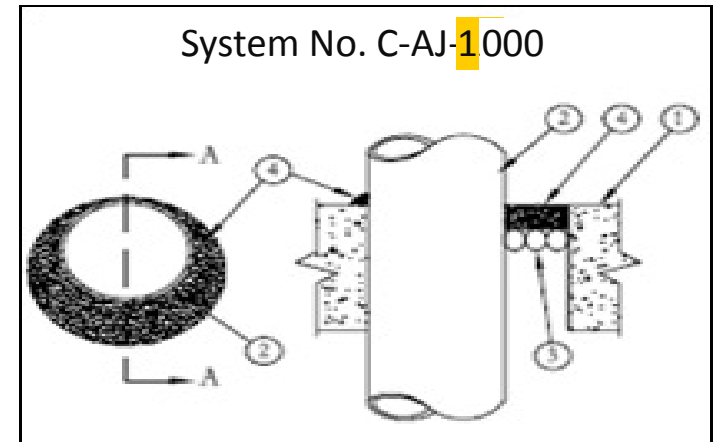

Example:

- Penetrating item is metallic pipe, conduit, or tubing

Intertek System Nomenclature

Another recognized accredited third-party testing facility which tests products to ensure they meet prescribed fire and flammability requirements is Intertek Group (Intertek).

With respect to through penetration firestop systems, Intertek uses a simplified naming convention. In general, it follows AAB/XX(X) YY(Y)-ZZ, where:

- AA - a designation unique to every company
- B - the country designation; U is for the United States
- XX(X) - a two or three letter designation for listing type
- PV - penetration vertical
- PH - penetration horizontal
- YY(Y) - a two or three number designation for the fire duration in minutes, and
- ZZ - the unique listing number for similar penetration types starting at 01.

Intertek System Nomenclature

Here is an example Intertek listing for XX company in the United States (xxU). It is for a vertical (floor) penetration (PV). It is a 60-minute listing (60) and is the fourth, 60-minute vertical penetration listing for this company (-04).

Design No. XXU/PV 60-04
January 25, 2008
PENETRATION FIRESTOP THROUGH FLOOR/CEILING ASSEMBLY
Fire Barrier Duct Wrap
Fire Barrier Water Tight 1000- Silicone Joint Sealant
ISO 6944 (1985)
Stability – 1 hr
Insulation – 1 hr
Integrity – 1 hr

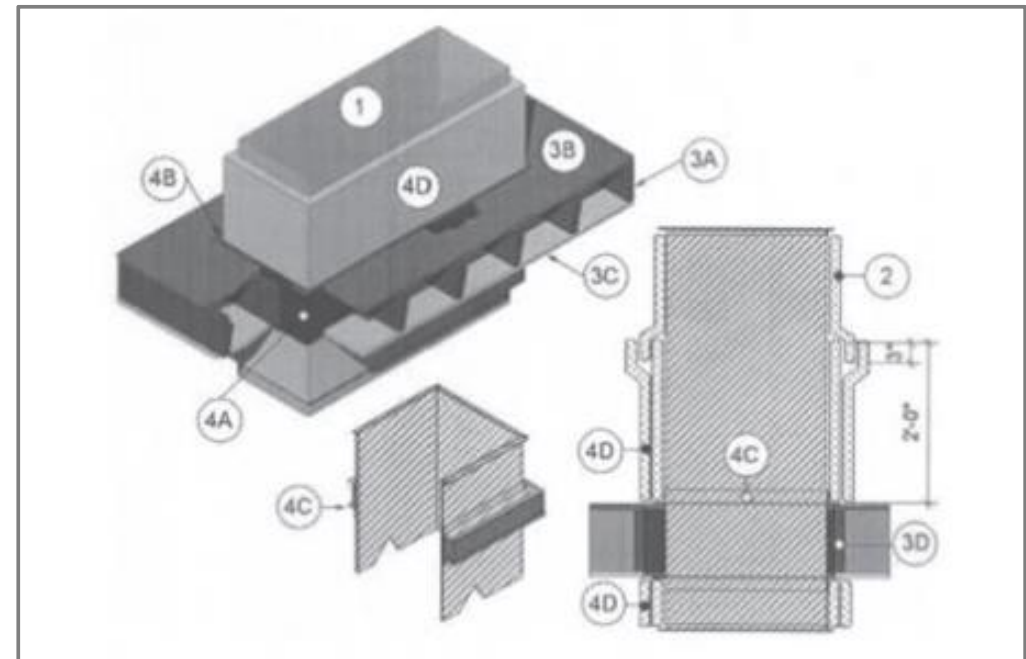

Engineering Judgments

An alternative to tested and listed systems is an engineering judgment (EJ). An EJ can be provided by the manufacturer when a tested and listed system for a specific condition does not exist. EJs are site and application specific and are intended to supply a solution to an application outside the scope of a tested system.

Installation details from tested and listed systems may differ slightly from your company procedures. Always check the practice of the particular company for which you are working for exact application specifics.

Important Notes to Remember

- Due to the wide variety of construction materials and practices, fully tested systems that have been listed by accredited third-party agencies should be used.
- Engineering judgments are an alternative to listed systems.
- Firestop materials are not systems; systems employ firestop materials.
- Products do not receive ratings; systems do.



Firestop Products & Applications

Through Penetration Firestop Products

Through penetrations are firestopped with one or a combination of the following materials and products as discussed on the following slides:

- foams
- sealants (including water-tight sealants and silicone sealants)
- pass-through devices
- cast-in devices
- putty sleeve kits
- mortar
- moldable putty
- wrap strips/rolls and graphite-based wrap
- restricting metal collars
- plastic pipe devices
- composite sheets, and
- pillows and self-locking pillows.

Benefits of Through Penetration Firestop Products

Fire protection products used in commercial firestopping:

- help prevent the spread of fire, smoke, and toxic gas (up to four-hour systems)
- have been tested by independent, accredited third-party test agencies for use in listed systems, and
- meet the intent of LEED® VOC Environmental Regulations (helps reduce the quantity of indoor air contaminants that may be odorous, irritating, and harmful to the comfort and well-being of the installers and occupants).

Additionally, many products:

- provide STC ratings to reduce airborne sound transmissions
- act as a cold air barrier, smoke barrier, and draftstop
- prevent water intrusion
- resist mold and fungi, and
- provide cable management.

Consult individual manufacturers for specific details about their products and any relevant testing data.

Foams

Foams used for firestopping through penetrations are typically used in mechanical and electrical applications to firestop complex openings created by the following penetrations in fire-rated floors, floor/ceilings, or walls:

- metallic pipe
- plastic pipe up to 1"
- insulated pipe
- HVAC duct penetrations
- conduit, power, and communication cable
- cable trays and combos
- blank openings, and
- line sets.

These foams are commonly tested against the spread of fire, smoke, and toxic gases for up to two hours, and also act as a barrier to airborne sound transmission.

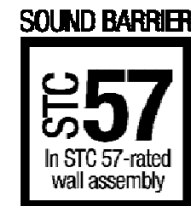

Sealants

In addition to mechanical and electrical applications, general and high-performance sealants are used in plumbing applications to firestop single or multiple through penetrations in fire-rated floors, floor/ceilings, or walls created by:

- metallic and insulated pipe
- plastic pipe (excluding CPVC)
- HVAC duct penetrations
- conduit, power, and communication cable
- cable trays, busways, and combos
- blank openings, and
- static construction joints.

General and high-performance sealants are tested against the spread of fire, smoke, and toxic gases for up to three or four hours, to act as an acoustic barrier, and resist the growth of mold. Latex-based elastomeric sealants are used to firestop construction joints with $\pm 19\%$ movement capability.

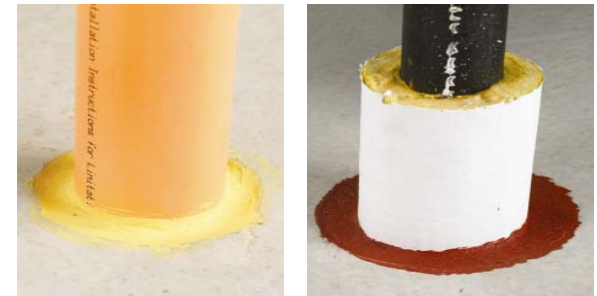

SOUND BARRIER

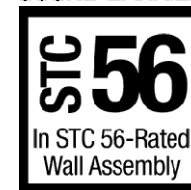

FIRE BARRIER



ELASTOMERIC



SMOKE SEAL



Sealants

Intumescent silicone sealants protect against fire for up to four hours, and meet the UL W-rating Class 1 requirements for water-tightness.

Depending on the manufacturer, water-tight sealants provide excellent adhesion on most construction surfaces, including concrete, gypsum, metal, plastic (CPVC compatible), wood, and insulation, and may meet the requirements for use on systems listed in the following categories:

- 0000 - blank openings
- 1000 - metallic pipes
- 2000 - non-metallic pipes
- 3000 - cables
- 5000 - insulated pipes
- 7000 - HVAC ducts, and
- 8000 - combinations.



<p>SOUND BARRIER</p> <p>STC 53</p> <p>In STC 54-Rated Wall Assembly</p>	<p>FIRE BARRIER</p> <p>UP TO 4 HOUR</p> <p>Fire Protection</p>
<p>WATER BARRIER</p> <p>MEETS CLASS 1W</p> <p>Rating</p> <p>UL Water Leakage</p>	<p>SMOKE SEAL</p> <p>L RATED</p> <p>Meets Optional L Requirements</p>

Pass-Through Devices

Pass-through devices are one-piece, round or square, hinged metal firestop enclosures which are ideal to firestop electrical, data, or communication cable or pipes that penetrate fire-rated floors or walls. They are re-enterable for single or multiple penetrants, and blank openings in new or retrofit construction. In certain applications, they may be stackable.

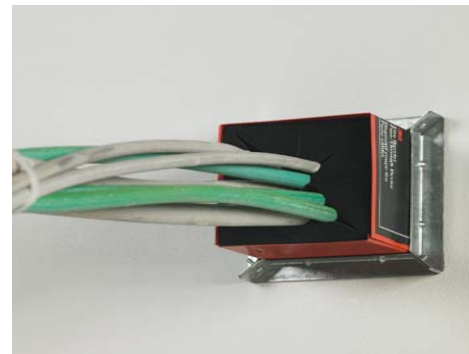
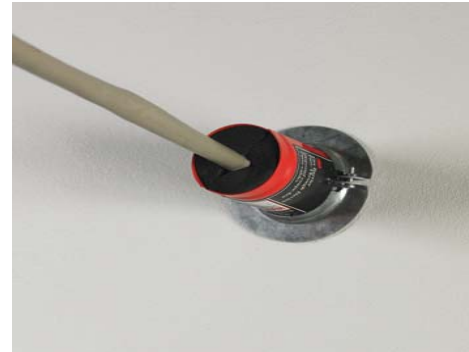

FIRE BARRIER SMOKE SEAL



Cast-In Devices

Cast-in devices are one-piece, plastic body assemblies designed for affordable firestopping of penetrating items that pass through concrete forms. Depending on the manufacturer, different designs may be available to accommodate different depths of concrete, widths of penetrant, and deck heights.

Cast-in devices are installed prior to the concrete pour and attached directly to wood forms as required. They can be adjusted before or after the pour to various concrete depths with pliers, and once the concrete cures, the penetrant (e.g., pipe) can be passed through.



Putty Sleeve Kits

Putty sleeve kits are ideal for firestopping existing through penetration openings with cables, future cable installations (blank openings), or new construction through penetration openings for various types of power and communication cables.

The sleeves can be split/hinged for existing installations and are 0% to 100% fillable.

Consult individual manufacturers for specific details regarding the contents of a putty sleeve kit, since the size of the opening and any penetrating items should be sized appropriately for a selected sleeve kit to allow for proper installation and seal.

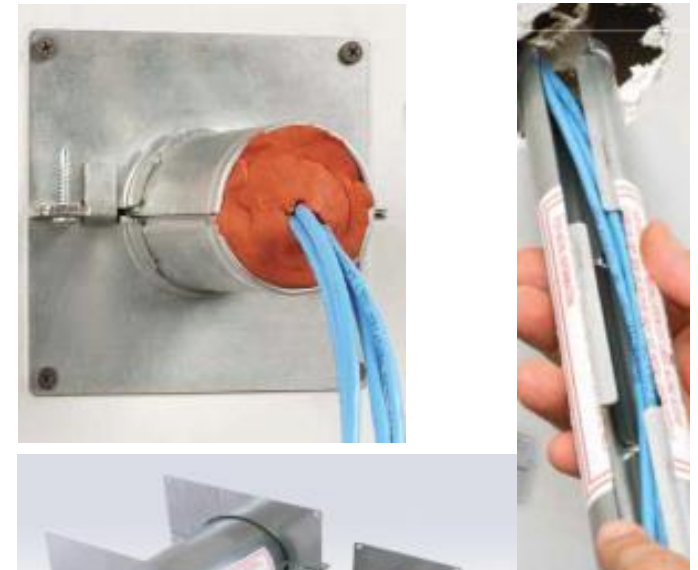

FIRE BARRIER SMOKE SEAL



Mortar

Mortar is a lightweight, endothermic firestop that is ready for mixing with potable water. It is used to firestop penetrations passing through fire-rated floor or wall assemblies and offers up to a three-hour rating.

Mortar acts as a heat sink, reducing the likelihood of combustible matter igniting on the unexposed side of the assembly.

Mortar with a variable mix ratio permits self-leveling as well as trowel-able application, and specific formulations bond to concrete, metals, wood, plastic, and cable jacketing. Another advantage to mortar is that it is re-enterable/repairable with common trade tools.



FIRE BARRIER



Moldable Putty

Moldable putty, available in pads and sticks, provides firestopping for a wide variety of through penetration applications. Moldable putty helps prevent the spread of fire, smoke, and noxious gas, and also acts as a draft and cold smoke seal for systems with L-ratings. In addition to its fire-resistant properties, moldable putty has airborne sound reduction characteristics which help to minimize sound transmission through assemblies requiring an STC rating.

The pads and sticks are used to firestop cable bundles, insulated pipe, electrical conduit, and metal pipe. Small pads are used as a wall opening protective to meet building requirements, and for the protection of membrane penetrations made by steel or listed non-metallic electrical boxes.



Wrap Strips & Rolls

An ideal solution for ease of installation in new and retrofit settings for firestopping plastic or non-metallic penetrations is a wrap strip. Precut strips are designed to fit various sizes of pipe, or alternatively, a roll of the wrap can be easily cut to a desired size.

Tuck-in wrap strips are engineered primarily for top-side firestop installations and help to eliminate the need for retaining collars, concrete screws, ladders, or other material and equipment necessary for bottom-side installation. The wrap strips also have the ability to be used within concrete and gypsum wallboard assemblies.



Wrap Strips

One-part, fire-resistive wraps with foil on one side are designed to firestop metallic and non-metallic pipes, insulated pipes, and cable bundles (“in-hole” applications or as part of a collar assembly).

These strips can be cut to fit irregular-shaped openings, making them ideal for new or retrofit applications.



FIRE BARRIER



SMOKE SEAL



Graphite-Based Wrap

A quick, easy, and cost-effective means of firestopping insulated pipe, non-metallic pipe, and combo penetrations in fire-rated wall, floor, and floor/ceiling assemblies is graphite-based wrap.

When a graphite-based wrap is installed “in-hole” in conjunction with a sealant or moldable putty, it also provides a cold smoke seal which helps to prevent the spread of toxic gases and other combustion by-products, even before heat initiates the intumescent process.



FIRE BARRIER
UP TO **4** HOUR
Fire Protection

SMOKE SEAL
L RATED
Meets Optional
L Requirements

Restricting Metal Collars

Restricting metal collars work in conjunction with wrap strips for firestopping penetrations in wall, floor, and floor/ceiling assemblies.

These steel collars are designed to hold the wrap strip in place and provide anchor tabs for securing the collar assembly to the wall or floor.

Collars are required for plastic pipes larger than 4" (101 mm) in diameter that have been firestopped with a wrap strip.

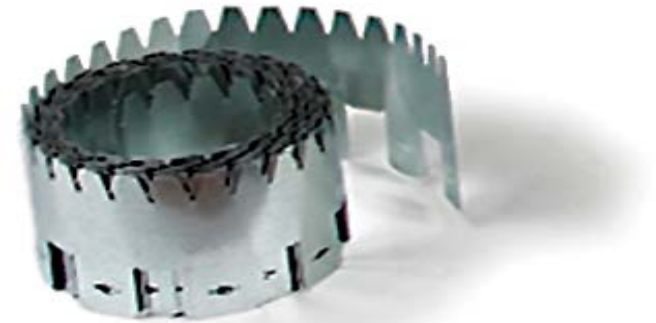

Plastic Pipe Devices

Plastic pipe devices are one-piece metal collar assemblies that encase a heat-expanding intumescent material that quickly seals around the penetrating item in the event of a fire. Available in various sizes, they are designed to accommodate electrical, drain, waste, vent, and closed pipe systems.

The devices can be mounted easily and quickly using anchors—no power tools, mounting screws, or other fasteners are needed. They are ideal for hotels, hospitals, condominiums, and other construction requiring many plumbing, electrical, and HVAC penetrations that pass through concrete flooring.



Composite Sheets

Composite sheets can be used to firestop any shaped opening in gypsum walls, concrete block, or slabs for up to four hours. Because they are re-enterable, they are also used to shield cable trays, conduit, HVAC ductwork, panels, valves, and vital heat-sensitive process equipment, and are effective in protecting cable drop-outs, junction boxes, and cabinets, as well as in providing an intermittent firestop in horizontal and vertical cable tray runs.



Pillows

Self-contained, highly-intumescent pillows provide a re-enterable solution for firestop systems. Pillow products expand and lock into place to surround the penetrant(s) and help stop smoke, fire, and toxic gases from spreading.



Please remember the **exam password PILLOW**. You will be required to enter it in order to proceed with the online examination.

Self-Locking Pillows

Self-locking pillows have interlocking strips incorporated into their design to hold them securely together, yet release and detach easily for retrofit or reuse.

Multiple pillow sizes and the ability to field-cut allow for a secure fit in most openings to firestop a wide variety of through penetrations, including cable trays, conduit, and blank openings. The cut edges can be sealed with a polypropylene box sealing tape.



FIRE BARRIER



SMOKE SEAL



Residential & Non-Rated Construction Assemblies

It's important to note that some through penetration firestopping products in today's market are intended for use in residential and other non-rated (Type V) construction only. These products, mainly foams and sealants, do not pass firestop testing per ASTM E814, and as such, should not be used in most commercial construction classifications as they do not meet applicable code requirements. These products are typically sold for residential fire block/draftstop applications, where firestop ratings are not required.





Course Summary

- Firestopping of openings in fire-rated construction re-establishes the integrity and fire rating of a wall, floor, or assembly, and aids in the protection of escape routes.
- The four main through penetration firestop technologies are: intumescent, endothermic, ablative, and insulative.
- Fire protection products used in commercial firestopping help prevent the spread of fire, smoke, and toxic gas (up to four-hour systems), have been tested by independent and accredited third-party test agencies for use in listed systems, and meet the intent of LEED® VOC Environmental Regulations.
- Additionally, many products provide STC ratings to reduce airborne sound transmissions; act as a cold air barrier, smoke barrier, and draftstop; prevent water intrusion; resist mold and fungi; and provide cable management.
- The two commonly cited fire protection standards for through penetrations are:
 - ASTM E814 Standard Test Method for Fire Tests of Penetration Firestop Systems, and
 - UL 1479 Fire Tests of Through-Penetration Firestops.

Course Summary

- UL tested through penetration firestop systems are identified by an alphanumeric identification system: the first alpha component identifies the type of assembly being penetrated, the second alpha component(s) identify the construction type, and the numeric component identifies the type of penetrating item and system manufacturer.
- When cables, pipes, electrical boxes, or similar items penetrate only one side of a wall, floor, or floor/ceiling assembly, the condition is known as a membrane penetration.
- Due to the wide variety of construction materials and practices, fully tested systems that have been listed by accredited third-party agencies should be used. Engineering judgments are an alternative to listed systems.
- Firestop materials are not systems; systems employ firestop materials. Products do not receive ratings; systems do.
- Through penetrations are firestopped with the following materials and products: foams, sealants, pass-through devices, cast-in devices, putty sleeve kits, mortar, moldable putty, wrap strips/rolls and graphite-based wrap, restricting metal collars, plastic pipe devices, composite sheets, and pillows and self-locking pillows.

Conclusion

If you desire AIA/CES, state licensing or CE credits for another organization, please click on the button to commence your online examination. A score of 80% or better will allow you to print your Certificate of Completion; you may also go to your AEC Daily Transcript to see your completed courses and certificates.

For additional knowledge and post-seminar assistance, click on the Ask an Expert link above.

If you have colleagues that might benefit from this seminar, please let them know. Feel free to revisit the AEC Daily website to download additional programs from the Online Learning Center.

MORE >



©2014 3M. The material contained in this course was researched, assembled, and produced by 3M and remains its property. "LEED" and related logo is a trademark owned by the U.S. Green Building Council and is used by permission. The LEED® Rating System was authored by and is the property of the USGBC. Any portion of the Rating System appearing in this course is by permission of the USGBC. Questions or concerns about the content of this course should be directed to the program instructor. This multimedia product is the copyright of AEC Daily.

Questions?

Ask an Expert – [click here](#)

Click Here to Take the Test

Exit